

# **F132/F136 User Instructions**

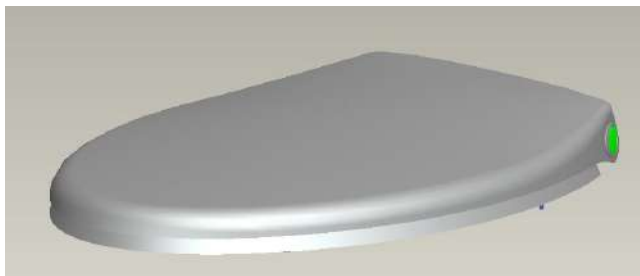

## **Statement:**

Oceanwell( Xiamen) Industrial Co., Ltd. (hereinafter as Oceanwell) declare seriously that toilet seat models F132 and F136 conform to the below requirements:

**2004/108/EC** (Certification No.: AT1012746E)

This declaration can be found through follow website:

<http://XXXXXXXXXXXXXXXXXXXXXXX>

## **Patent document (patent number and content)**

Following the sustainable development strategy, Oceanwell reserve the right to modify and improve the mentioned toilet seats without advance notice.

In any situation, Oceanwell do not assume responsibility for losses in data, income, or any incidental, consequential losses caused by any reason.

The contents of this document are based on the “current state”, and Oceanwell neither commit specifically, acquiescently or in any way to its accuracy, reliability, nor commit to the marketability, applicability of specific usage. Oceanwell reserve the right to modify and improve the mentioned toilet seats without advance notice.

## **Safety Cautions:**

Please read these simple instructions before using the toilet seat. Failure to follow the instructions may put you at risk or lead to malfunction.



### Appearance Protection

Don't contact toilet seat with hard or sharp objects to avoid breaking its appearance and shape.



### Safety Tips

Never step on the toilet seat or strike it with heavy objects to avoid personal injury or property loss.



### Usage

Don't force the cover to close to avoid malfunction of the soft close function or deduction of the soft close mechanism life.



### Cleaning

Don't use NaCO<sub>3</sub>, NaOH or any other corrosive detergents to wipe the seat to avoid harm to the seats or your skin.



### Rational use

As described, the toilet seat works better if you use it reasonably under right circumstances.



### Professional installation and maintenance

Only professional operator can install and maintain the seat.



### Original spare parts

Please use original parts or approved fittings, don't freely use unsuitable fittings.

## Care and Cleaning:



### Refrain from water

Don't clean the toilet seat by a rapid flow of water, to avoid any damage to its internal electronic parts, leading to partial malfunction.



#### Refrain from soaking in water

Don't submerged toilet seat in the water, to avoid any damage to its internal electronic parts, leading to partial malfunction.



#### Correct cleaning

Wipe it with clean dry soft cloth.

### Product Parameter:

|                                    |                          |                          |
|------------------------------------|--------------------------|--------------------------|
|                                    | F132                     | F136                     |
| Material                           | UF                       | UF                       |
| Net weight                         | 2.42Kg                   | 2.56Kg                   |
| Dimensions                         | 482*362*67(mm)           | 446*376*66(mm)           |
| Rated Load Voltage                 | 3V                       | 3V                       |
| Rated Current                      | 6mA                      | 6mA                      |
| Rated capacity                     | 18mW                     | 18mW                     |
| Voice-activated sensor sensitivity | peak<br>80dBSPL±6dB@1KHz | peak<br>80dBSPL±6dB@1KHz |

### Product Illustration:

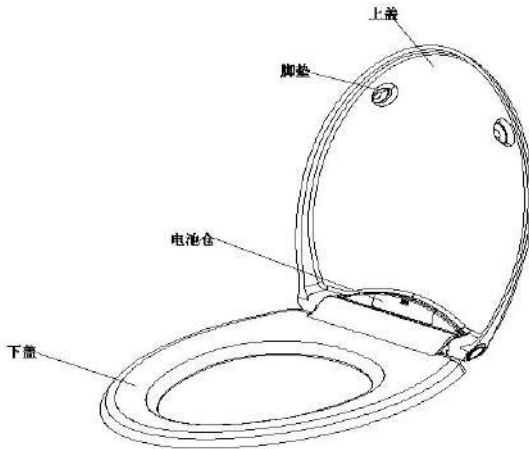
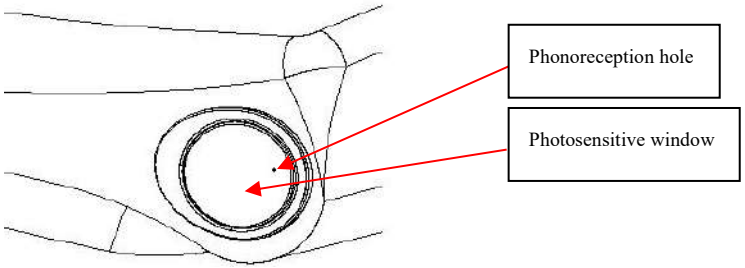
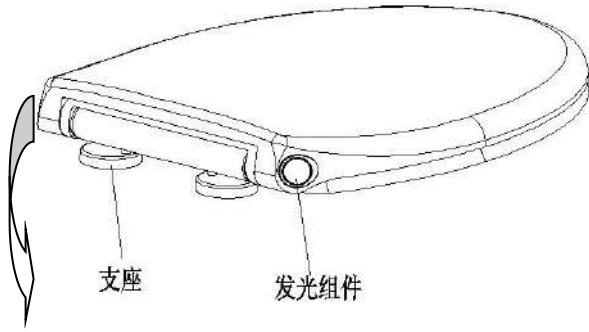

## Toilet seat part lists:

| Item | Parts name   | Quantity |
|------|--------------|----------|
| 1    | Seat set     | 1        |
| 2    | Hinge        | 2        |
| 3    | Hinge cover  | 2        |
| 4    | Hinge gasket | 2        |
| 5    | Nut          | 1        |
| 6*   | battery      | 2        |
| 7    | Manual       | 1        |

\*Partial toilet seat are not equipped with the battery.

## Installation instruction:

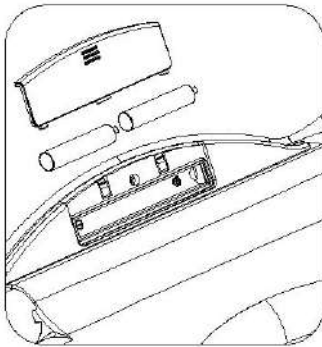

Open the toilet cover and push the battery box cover backward to open it. Identify the negative pole A and positive B marked in the battery housing. Place two batteries into the housing and then cover it.

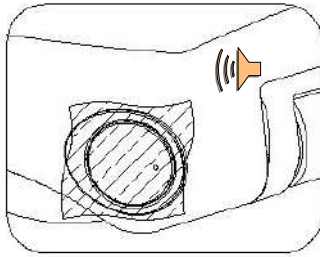

Cover the photosensitive window by your hand or an opaque cloth, and then make a sound. If the seat gives out light, it turns out that the function works normally.

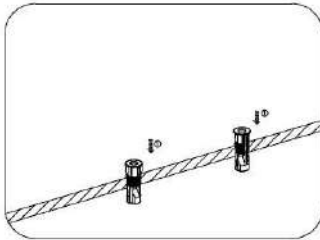

1. Insert the nuts into the toilet fixing holes.

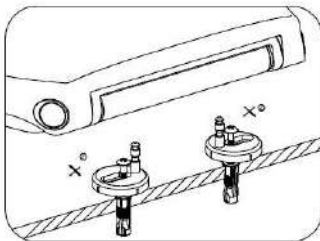

2. Attach the hinge plate with the bolt onto the ceramic, and then fix the bolt into the nut.



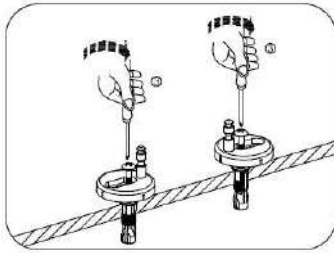

3. Tighten the fixing bolt gently by a screw driver.

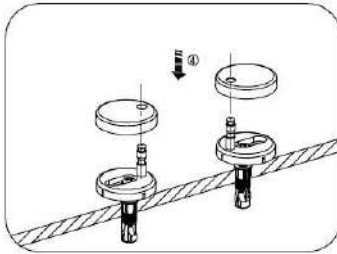

4. Cover the hinge.

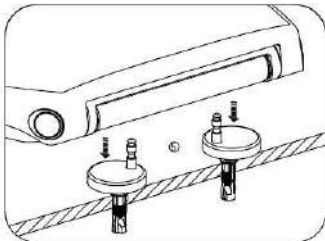

5. Attach the seat onto the hinge pins. "Click" proves the mounting is sound.

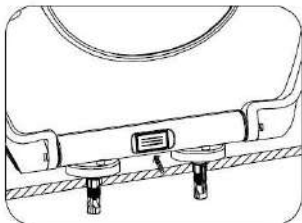

5. For cleaning, press the button in and lift the seat off.

## Battery

| Battery           | Species       | Working time* | Quantity |
|-------------------|---------------|---------------|----------|
| 7#(LR03/AM-4/AAA) | alkaline cell | 3-4 months    | 2        |

\*The LED light working time listed above is got under a theoretical circumstance. The actual working time may be longer or shorter due to the effect of battery quality, bathroom lighting, toilet pan's position, the surrounding noise and circumstance.

## Function specification:

It is an intelligent seat with LED light at each side of its ring. The light is voice and light activated, working at night only. The light does not function in daytime or when there is light already in the bathroom. When it is dark around, the light sets start to sense sound, a sound loud enough (peak 80dB SPL±6dB@1KHz) will turn on the light. The light lasts 2 minutes and stops for 15 seconds before another activation. One will not be wakened up by the dizzy light in the bathroom at mid-night.

\*The above dates are theoretical laboratory data. The actual sensitivity will be

affected by the toilet pan's installation position and the surrounding circumstance.

### The Common Problems and Treatment:

| Item | Problem  | Treatment   |
|------|--|---|
| 1    | The light fails to work normally.              | <ol style="list-style-type: none"><li>1. Check to ensure that the batteries are suitable.</li><li>2. Check to ensure that there is no strong light in the bathroom.</li><li>3. Check to ensure that the sound is loud enough.</li></ol> |
| 2    | The light lasts less than 2 minutes            | Low power; please use a new set batter.   |
| 3    | The light keeps working without stop at night. | Check to ensure that it is not too noisy around the bathroom.   |

If the light fails to work normally though the above treatments have been taken, please purchase the light set from after-sale service department and replace the old one as follows:



1. Draw the light set outward by a thin hard object.



2. Disconnect it from the connector on the base plate.



3. Fetch a new light set; insert the cable and connectors into the light set (black plug fitted into black socket)





4. Fix the light set into the housing correctly.